

Thomas[®]

Flexible Disc Couplings

SERIES 71 SPACER COUPLING

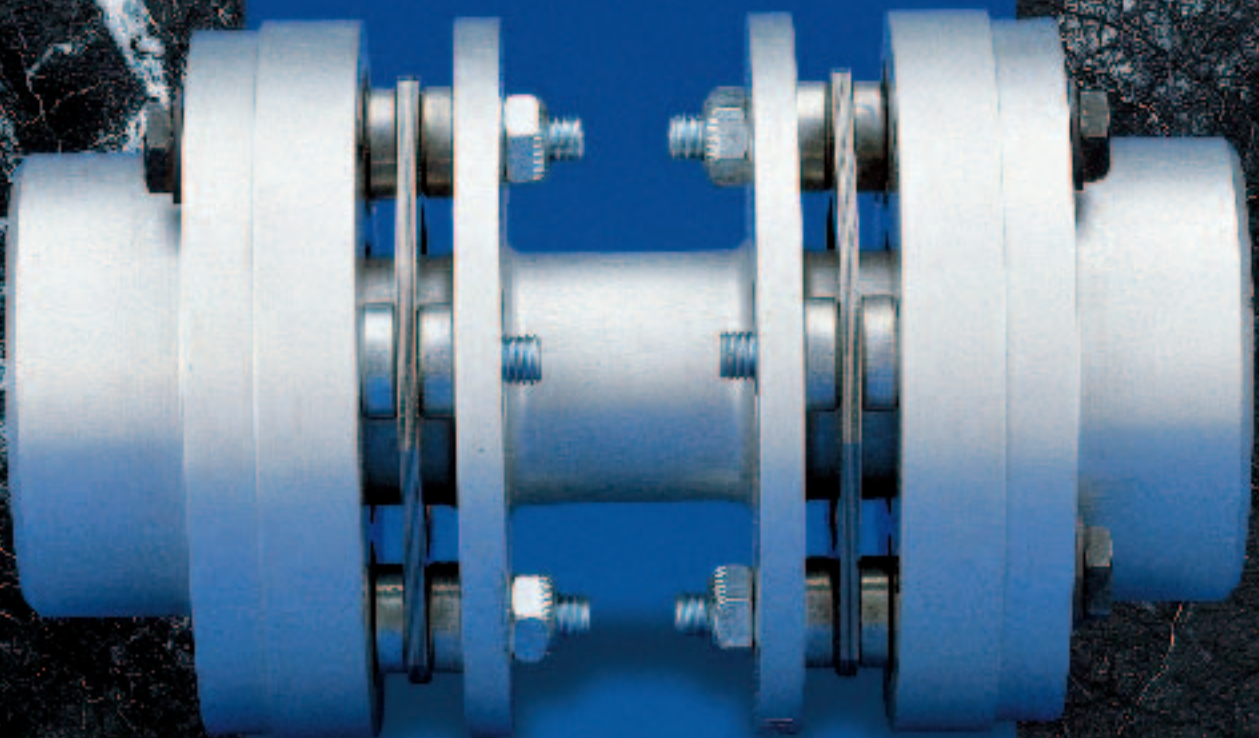

Now with increased
torque ratings, larger bore
capacities, and extended sizes.

Rexnord
|||||

SERIES 71, DESIGNED FOR THE USER... HERE'S WHY:

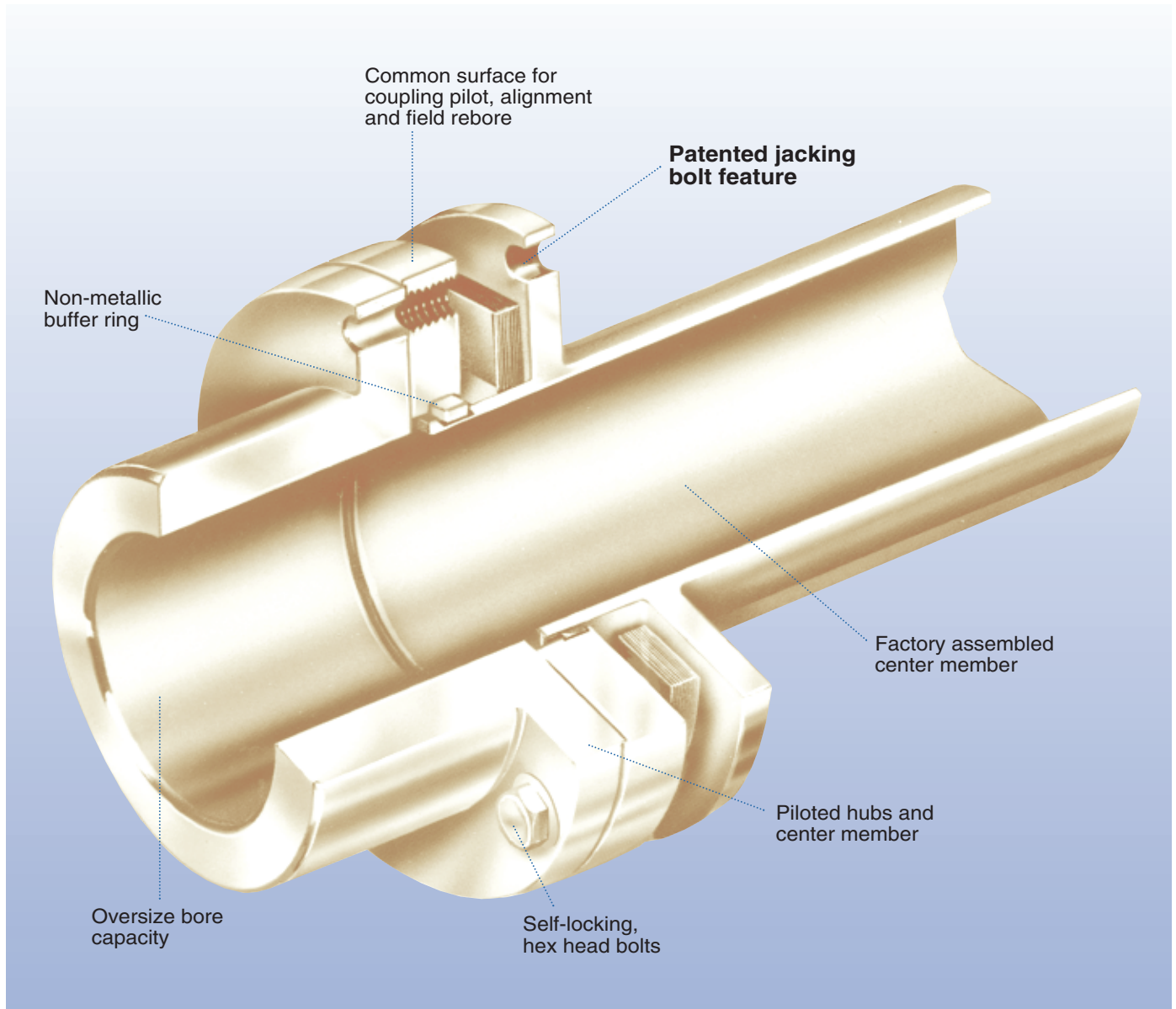

- Fewer parts — three piece design features unitized center member and two piloted fit hubs
- Quick installation — no special wrenching, easily accessible bolting
- Easy alignment — piloted flanges, common reference surface
- Patented jacking bolt feature compresses coupling for easy installation and removal of center assembly
- Optimized 4, 6 and 8 bolt designs
- Disc design provides low flexing forces with high overload capacity
- Manufactured to AGMA Class 9 balance specification when finish bored
- Meets API 610 requirements when puller bolt holes are specified

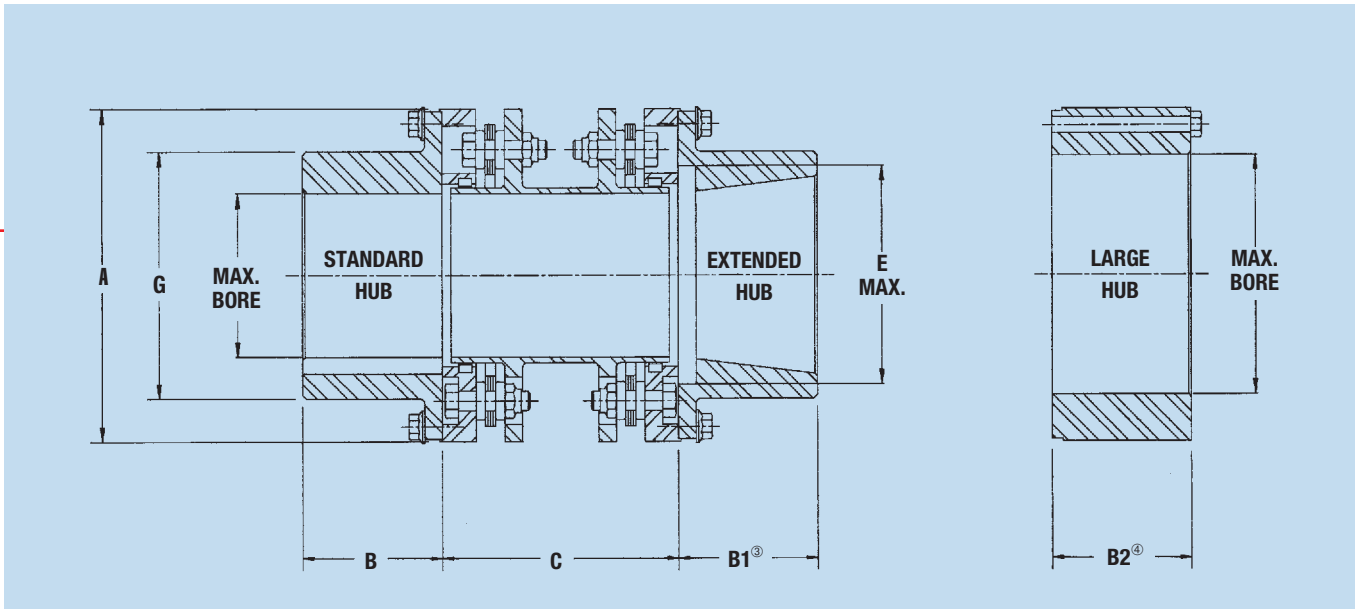

Stocked "C" Dimensions

General Dimensions — Inches

Coupling Size	"C" Dimension (In.)								Coupling Size	B & B1 Hub Max. Bore \varnothing	B2 Hub Max. Bore \varnothing	A	B	\varnothing B1	\varnothing B2	Std. C	Min. C	Max. E	G
	3-1/2	4-3/8	5	5-1/2	7	7-1/2	8	9											
150	•								150	1.500	2.375	3.59	1.31	1.69	1.62	3.50	3.44	2.06	2.31
175	•	•							175	1.875	2.750	4.16	1.56	2.06	1.81	3.50	3.44	2.56	2.81
225	•		•						225	2.250	3.250	4.94	2.00	2.50	2.06	5.00	3.44	3.09	3.34
300			•	•					300	3.000	4.000	5.97	2.62	3.25	2.75	5.00	4.00	4.12	4.44
350			•	•	•				350	3.500	4.500	6.75	3.12	3.75	3.00	5.00	5.00	5.00	5.25
375			•	•	•				375	3.750	5.000	7.62	3.25	4.00	3.25	5.50	5.00	5.31	5.66
412				•	•	•			412	4.125	—	8.00	3.62	4.38	—	7.00	6.50	5.75	6.09
462					•	•	•		462	4.625	—	9.00	4.12	5.00	—	7.00	7.00	6.31	6.84
512						•			512	5.125	—	10.03	4.50	5.38	—	7.00	7.00	7.06	7.62
562							•		562	5.625	—	10.97	5.00	6.00	—	8.00	8.00	7.69	8.38
600								•	600	6.000	—	11.72	5.25	6.38	—	9.00	9.00	8.31	8.94
712									712	7.125	—	13.88	6.25	—	—	9.38	8.88	10.18	10.75
800									800	8.000	—	15.56	7.00	—	—	10.88	10.25	11.37	12.00
875									875	8.750	—	17.12	7.75	—	—	12.00	11.38	12.50	13.12
1038									1038	10.375	—	19.75	9.00	—	—	14.00	13.25	14.87	15.56

For "C" dimensions other than shown, consult Rexnord.

Engineering Data

Coupling Size	Max. Horsepower Per 100 RPM Service Factor					Max. RPM \varnothing		Max. Continuous Torque (Lb.-In.)	Peak Overload Torque (Lb.-In.)	Weight (Lbs.) \varnothing	Weight Change Per Inch of "C" (Lbs.)	WR ² (Lb.-In. ²) \varnothing	WR ² Change Per Inch of "C" (Lb.-In. ²)	Axial Deflection (In.) \varnothing	No. of Bolts Per Disc
	1.0	1.5	2.0	2.5	3.0	Not. Bal. \varnothing	Balanced								
150	1.5	.98	.74	.59	.49	9,000	20,800	930	1,860	6.7	.10	10.6	.03	±.050	4
175	2.6	1.7	1.3	1.0	.86	8,300	17,000	1,630	3,260	9.4	.14	20.6	.09	±.070	4
225	4.8	3.2	2.4	1.9	1.6	7,700	16,000	3,060	6,120	14	.19	42	.25	±.075	6
300	11.5	7.7	5.8	4.6	3.8	6,800	14,000	7,260	14,520	26	.26	121	.66	±.085	6
350	21.2	14.2	10.6	8.4	7.1	6,200	13,500	13,400	26,800	43	.42	259	1.18	±.090	6
375	30.6	20.4	15.3	12.2	10.2	5,650	12,000	19,300	38,600	55	.43	423	1.62	±.095	6
412	35.7	23.8	17.8	14.3	11.9	5,350	11,000	22,500	45,000	71	.60	615	2.90	±.110	6
462	64.1	42.7	32.1	25.6	21.4	5,000	10,000	40,400	80,800	101	.80	1,110	4.65	±.120	6
512	87.3	58.2	43.6	34.9	29.1	4,700	9,200	55,000	110,000	135	1.04	1,830	7.43	±.130	6
562	133	89.0	66.7	53.4	44.5	4,350	8,300	84,100	168,200	186	1.28	3,020	10.38	±.145	6
600	145	97.0	72.8	58.2	48.5	4,150	7,800	91,700	183,400	228	1.75	4,250	17.51	±.160	6
712	174	116	87.0	69.6	58.0	3,450	7,200	110,000	220,000	355	1.37	9,090	16.9	±.082	8
800	255	170	128	102	85.0	3,250	6,800	161,000	322,000	504	2.17	16,200	33.2	±.092	8
875	373	250	187	149	123	3,050	6,400	235,000	470,000	672	2.41	26,200	45.6	±.102	8
1038	549	366	275	220	183	2,900	5,800	346,000	692,000	1,120	3.21	57,000	74.4	±.115	8

- ① See p. E-46 in the engineering catalog for explanation of RPM limits and balancing recommendations.
- ② Weight and WR² with standard length hubs, maximum bore and standard "C".
- ③ Extended hub length is designed longer in order to include a counter-bore for the threaded extension on a tapered shaft.
- ④ Large hub length. For sizes not shown, consult Rexnord.
- ⑤ Thomas Flexible Disc Couplings meet all NEMA (MG1-14.37) specifications without modification or additional end-float restricting devices.
- ⑥ Series 71 Coupling assembly meets AGMA Balance Class 9 when furnished with finished bores.
- ⑦ Hub sizes 150-600 furnished without a finished bore will be solid. Hub sizes 712 and larger will have a minimum rough bore when finish bore is not specified.

Note: Dimensions subject to change. Certified dimensions of ordered material furnished on request.

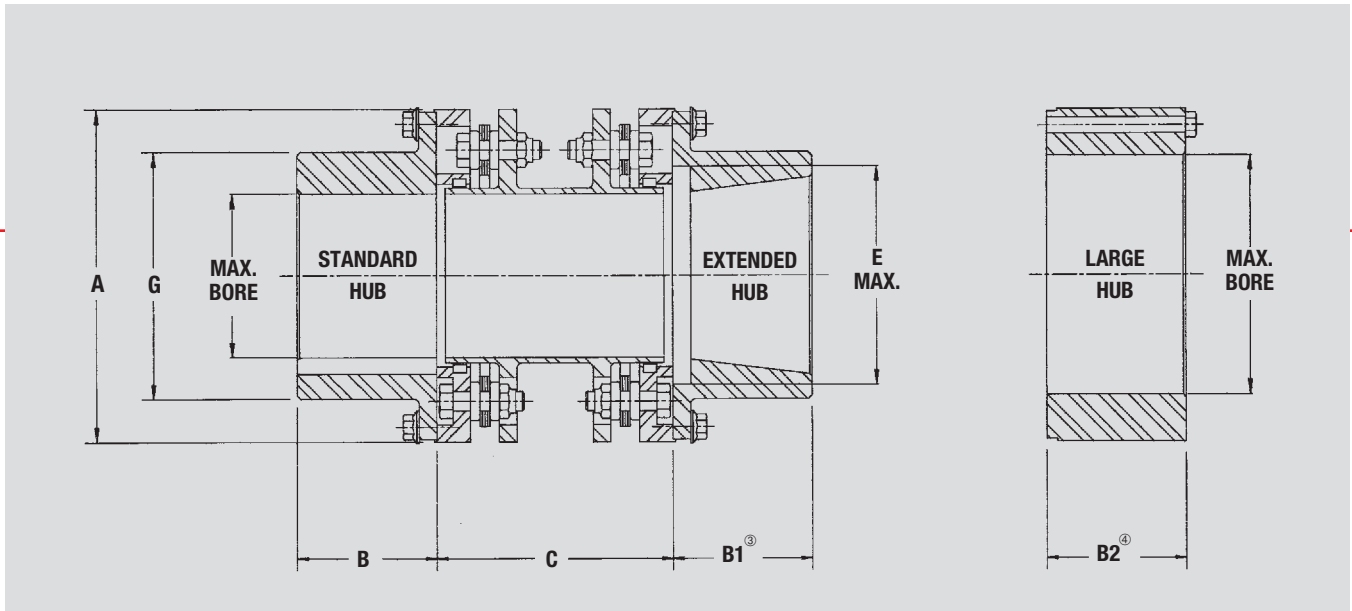

Stocked "C" Dimensions

General Dimensions — Millimeters

Coupling Size	"C" Dimension (mm)										Coupling Size	B & B1 Hub Max. Bore Ø	B2 Hub Max. Bore Ø	A	B	Ø B1	Ø B2	Std. C	Min. C	Max. E	G
	89	100	111	127	140	178	180	190.5	203.2	228.6											
150	•										150	38	—	91.28	33.3	42.9	41.3	89	87	52.3	58.7
175	•	•	•	•	•						175	48	70	105.6	39.7	52.4	46.0	89	87	65.0	71.4
225	•	•	•	•	•	•					225	58	83	125.4	50.8	63.5	52.4	127	87	78.5	84.9
300											300	76	102	151.6	66.7	82.6	69.9	127	102	104.6	112.8
350				•	•	•					350	89	114	171.5	79.4	95.3	76.2	127	127	127.0	133.4
375				•	•	•					375	95	127	193.7	82.6	101.6	82.6	139.7	127	134.9	143.7
412				•	•	•					412	105	—	203.2	92.1	111.1	—	178	165	146.0	154.8
462							•	•			462	118	—	228.6	104.8	127.0	—	178	178	160.3	173.8
512						•			•		512	130	—	254.8	114.3	136.5	—	178	178	179.3	193.7
562								•			562	143	—	278.6	127.0	152.4	—	203.2	203	195.3	212.7
600										•	600	152	—	297.7	133.4	161.9	—	228.6	229	211.1	227.0
712											712	181	—	352.4	158.8	—	—	238.1	225	258.6	273.1
800											800	203	—	395.3	177.8	—	—	276.2	260	288.8	304.8
875											875	222	—	435.0	196.9	—	—	304.8	289	317.5	333.4
1038											1038	264	—	501.7	228.6	—	—	355.6	337	377.7	395.3

For "C" dimensions other than shown, consult Rexnord.

Engineering Data

Coupling Size	Max. Kilowatt Per 100 RPM Service Factor					Max. RPM ①		Max. Continuous Torque (Nm)	Peak Overload Torque (Nm)	Weight (kg) ②	Weight Change Per cm of "C" (kg)	J (kg-cm²) ③	J Change Per cm of "C" (kg-cm²)	Axial Deflection (mm) ④	No. of Bolts Per Disc
	1.0	1.5	2.0	2.5	3.0	Not. Bal. ⑤	Balanced								
	Ø	Ø	Ø	Ø	Ø	Ø	Ø								
150	1.1	.73	.55	.44	.36	9,000	20,800	105	210	3.05	.017	32	.04	±1.3	4
175	1.9	1.3	.96	.77	.64	8,300	17,000	184	368	4.24	.025	60	.10	±1.8	4
225	3.6	2.4	1.8	1.4	1.2	7,700	16,000	346	692	6.30	.034	120	.29	±1.9	6
300	8.6	5.7	4.3	3.4	2.9	6,800	14,000	820	1,640	11.75	.046	360	.76	±2.2	6
350	15.8	10.6	7.9	6.3	5.3	6,200	13,500	1,515	3,030	19.4	.075	760	1.36	±2.3	6
375	22.8	15.2	11.4	9.1	7.6	5,650	12,000	2,180	4,360	25.1	.077	1,250	1.87	±2.4	6
412	26.6	17.7	13.3	10.6	8.9	5,350	11,000	2,540	5,080	32.0	.107	1,800	3.34	±2.8	6
462	47.8	31.9	23.9	19.1	15.9	5,000	10,000	4,565	9,130	45.8	.143	3,280	5.36	±3.0	6
512	65.1	43.4	32.5	26.0	21.7	4,700	9,200	6,215	12,430	61.2	.185	5,400	8.56	±3.3	6
562	99.5	66.4	49.8	39.8	33.2	4,350	8,300	9,500	19,000	84.4	.229	8,900	12.0	±3.7	6
600	108.5	72.4	54.3	43.4	36.2	4,150	7,800	10,360	20,720	103.4	.313	12,500	20.2	±4.1	6
712	129	86.8	65.1	52.1	43.4	3,450	7,200	12,400	24,800	161	.245	26,650	19.5	±2.1	8
800	190	127	95.3	76.2	63.5	3,250	6,800	18,200	36,400	229	.387	47,700	38.2	±2.3	8
875	278	185	139	111	92.7	3,050	6,400	26,500	53,000	305	.430	77,550	52.5	±2.6	8
1038	409	273	205	164	136	2,900	5,800	39,100	78,200	490	.573	165,000	85.7	±2.9	8

- ① See p. E-46 in the engineering catalog for explanation of RPM limits and balancing recommendations.
- ② Weight and WR² with standard length hubs, maximum bore and standard "C".
- ③ Extended hub length is designed longer in order to include a counter-bore for the threaded extension on a tapered shaft.
- ④ Large hub length. For sizes not shown, consult Rexnord.
- ⑤ Thomas Flexible Disc Couplings meet all NEMA (MG1-14.37) specifications without modification or additional end-float restricting devices.
- ⑥ Series 71 Coupling assembly meets ISO G6.3 BALANCE when furnished with finished bores. ISO G2.5 available when specified.
- ⑦ Hub sizes 150-600 furnished without a finished bore will be solid. Hub sizes 712 and larger will have a minimum rough bore when finish bore is not specified.

Note: Dimensions subject to change. Certified dimensions of ordered material furnished on request.

Selection Procedures

The following procedure is used to select disc couplings for most applications. Special consideration must be given to coupling selection for those applications involving abnormal loading or design. Rexnord engineers are readily available for selection advice and assistance.

Coupling Selection:





1. Determine HP/100 RPM:

$$\text{HP/100 RPM} = \frac{\text{Horsepower} \times 100}{\text{RPM}}$$

2. Determine Service Factor:
Select the proper Service Factor from the Table.
3. Select the Coupling Size.
4. Check Limiting Conditions:
 - a. Check maximum speed.
 - b. Check maximum bore.
 - c. Check other dimensions such as shaft separation, overall length, O.D. etc.
 - d. Check to be sure that the maximum torque to be transmitted, such as start-up or stall torques, do not exceed the coupling's Peak Overload Torque Rating.

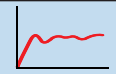
Service Factors

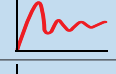
Service Factors are a means of classifying different equipment and applications into various load classifications. Due to variations in application of equipment, service factors are used to adjust equipment ratings to accommodate for variable loading conditions.

Load Classifications	Service Factors
 Continuous service and running loads vary only slightly.	1.0
 Torque loading varies during operation of the equipment.	1.5
 Torque loading varies during operation, frequent stop/start cycles are encountered.	2.0
 For shock loading and substantial torque variations.	2.5
 For heavy shock loading or light reversing drives.	3.0

Footnote:

The Service Factor Table considers the driven equipment only and assumes a normal electric motor or turbine driver. For prime movers of the reciprocating type (engines, etc.) add the following to the Service Factor:

- For 8 or more cylinders, add 0.5
- For 6 cylinders, add 1.0
- For 4 cylinders, add 1.5
- For less than 4 cylinders, consult Rexnord

Typical Service Factors Motor and Turbine Driven Equipment

Application	Typical Service Factor
Blowers	
Centrifugal	1.0
Lobe.....	1.5
Vane	1.5
Compressors	
Centrifugal	1.0
Lobe, Vane, Screw	1.5
Reciprocating – Multi-Cylinder.....	Consult Rexnord
Axial.....	1.0
Fans	
Centrifugal	
Forced Draft	
(Hostile Environment)	1.5
Induced Draft	
(Hostile Environment)	1.5
Axial	
Forced Draft	
(Hostile Environment)	1.5
Induced Draft	
(Hostile Environment)	1.5
Light Duty	
Blowers & Fans	1.0
Generators	
Non-Welding.....	1.5
Oil Industry	
Chillers.....	1.5
Oil Well Pumping	2.0
Paraffin Filter Press	2.0
Rotary Kilns	2.0
Pumps	
Centrifugal	
General Duty (Liquid).....	1.0
Boiler Feed	1.0
Slurry (Sewage, etc.)	1.5
Dredge.....	2.0
Reciprocating	
Double Acting	2.0
Single Acting	
1 or 2 Cylinders.....	2.5
3 or more Cylinders	2.0
Rotary – Gear, Lobe, Vane.....	1.5
Sewage Disposal Equipment.....	1.5
Sewage Treatment Pumps	1.5

Balance Recommendations

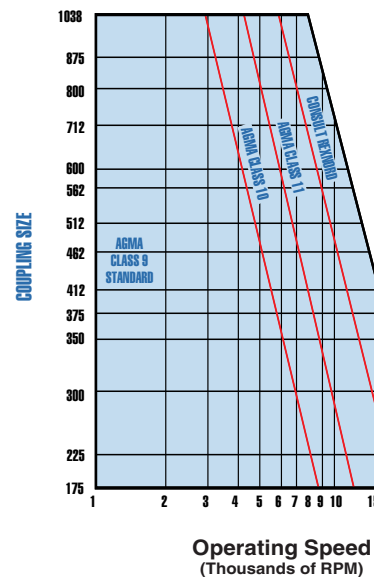

Note: The above recommendations and balance classes are based on AGMA Specifications 515.02, High Sensitivity. If conditions exist other than as defined in 515.03 for high sensitivity, consult Rexnord. The above information should be used as a guide only. AGMA Class 9 balance furnished as standard with finished bore couplings.



World Class Customer Service

For over 100 years the dedicated people of Rexnord have delivered excellence in quality and service to our customers around the globe. Rexnord is a trusted name when it comes to providing skillfully engineered products that improve productivity and efficiency for industrial applications worldwide. We are committed to exceeding customer expectations in every area of our business: product design, application engineering, operations and customer service.

Because of our customer focus, we are able to more thoroughly understand the needs of your business and have the resources available to work closely with you to reduce maintenance costs, eliminate redundant inventories and prevent equipment down time.

Rexnord represents the most comprehensive portfolio of power transmission and conveying components in the world with the brands you know and trust.

The Power of Rexnord™



FLATTOP

BEARINGS

GEARED
PRODUCTSINDUSTRIAL
CHAIN

COUPLINGS

AEROSPACE

SPECIAL
COMPONENTS

WORLDWIDE CUSTOMER SERVICE

AUSTRALIA

Rexnord Australia Pty. Ltd.
Picton, New South Wales
Phone: 61.2.4677.3811
Fax: 61.2.4677.3812

BRAZIL

Rexnord Correntes Ltda.
Sao Leopoldo - RS
Phone: 55.51.579.8022
Fax: 55.51.579.8029

CANADA

Rexnord Canada Ltd.
Scarborough, Ontario
Phone: 1.416.297.6868
Fax: 1.416.297.6873

CHINA

Rexnord China
Shanghai, China
Phone: 86.21.62701942
Fax: 86.21.62701943

EUROPE

Rexnord NV
Vilvoorde, Belgium
Phone: 32.2.255.8311
Fax: 32.2.720.1023

Rexnord Kette GmbH
Betzdorf, Germany
Phone: 49.2741.2840
Fax: 49.2741.284362

LATIN AMERICA

Rexnord International, Inc.
Milwaukee, Wisconsin
Phone: 1.414.643.3000
Fax: 1.414.643.3222

MEXICO

Rexnord S.A. de C.V.
Queretaro, Qro.
Phone: 52.442.218.5000
Fax: 52.442.218.1090

SINGAPORE

Rexnord International, Inc.
Singapore City, Singapore
Phone: 65.6338.5622
Fax: 65.6338.5422

UNITED STATES

Eastern Service Center
Smyrna, Georgia
Phone: 1.770.431.7200
Fax: 1.770.431.7299

Central Service Center
Grove City, Ohio
Phone: 1.614.675.1800
Fax: 1.614.675.1898

Southern Service Center
Arlington, Texas
Phone: 1.817.385.2800
Fax: 1.817.385.2873



Rexnord Coupling Group
5555 South Moorland Road
New Berlin, Wisconsin 53151
Phone: 1.800.767.3539 Fax: 1.262.796.4064
Visit us on-line at www.rexnord.com